

## Pipes

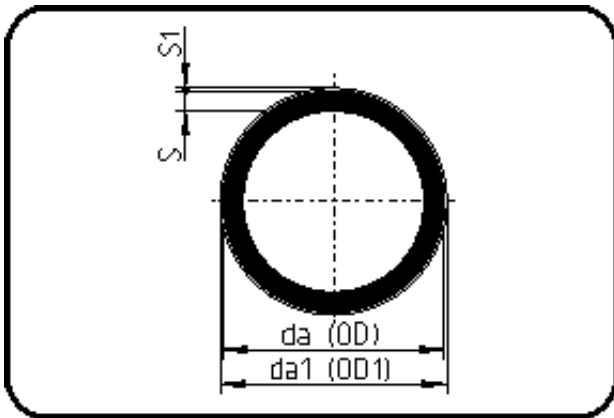

Code: 743.1

- Pipe SK+ fabric 1m
- Syn. fabric
- extruded
- ECTFE natural

Dim. 200x4.0mm on request.

Dimension	Code	Detail	Weight
63	40.743.1063.00	63x3,0	1.35

	Unit	Nominale	Tol+	Tol-
da(OD)	mm	63	0.60	0.00
s	mm	3	0.60	0.00
s1	mm	4,2	0.00	0.00
da(OD1)	mm	65,2	0.00	0.00