

Pipes

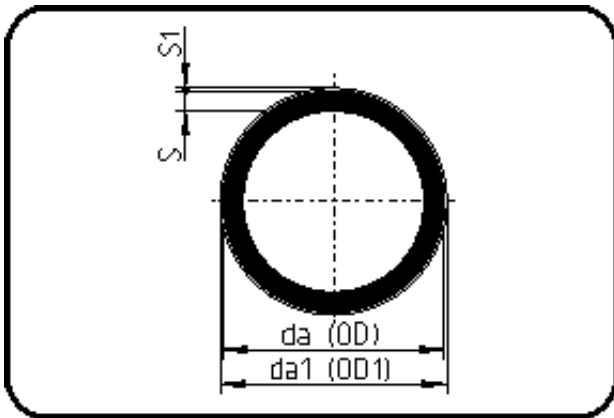

Code: 743

- Pipe SK+ fabric 5m
- Syn. fabric
- extruded
- ECTFE natural

Dim. 200x4.0mm on request.

Dimension	Code	Detail	Weight
110	40.743.0110.00	110x3,0	2.40

	Unit	Nominale	Tol+	Tol-
da(OD)	mm	110	1.00	0.00
s	mm	3	0.60	0.00
s1	mm	4,2	0.00	0.00
da(OD1)	mm	112,2	0.00	0.00