

Pipes

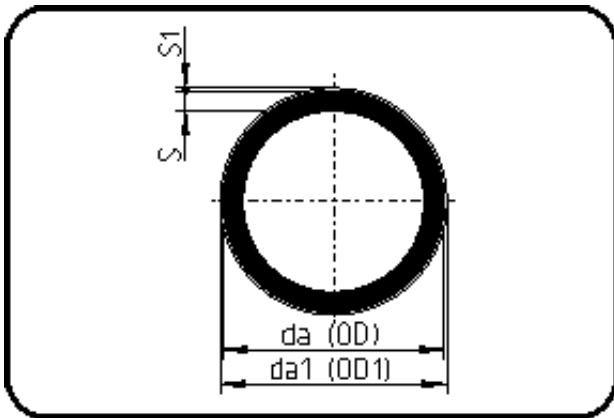

Code: 743.1

- Pipe SK+ fabric 1m
- Syn. fabric
- extruded
- ECTFE natural

Dim. 200x4.0mm on request.

Dimension	Code	Detail	Weight
160	40.743.1160.00	160x3,0	3.56

	Unit	Nominale	Tol+	Tol-
da(OD)	mm	160	1.50	0.00
s	mm	3	0.60	0.00
s1	mm	4,2	0.00	0.00
da(OD1)	mm	162,3	0.00	0.00