

Fittings

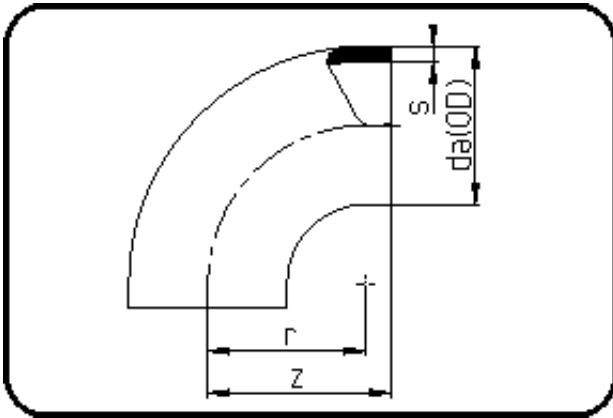

Code: 001

- Bend 90°
- short spigot
- injection moulded
- **Butt + IR-welding**
- PVDF natural HV

Dimension	Code	Detail	Weight
140	3H.001.0140.00	140X3,0	0.65

	Unit	Nominale	Tol+	Tol-
da(OD)	mm	140	1.30	0.00
r	mm	140	0.00	0.00
s	mm	3	0.60	0.00
z	mm	148	2.00	2.00