

## Pipes

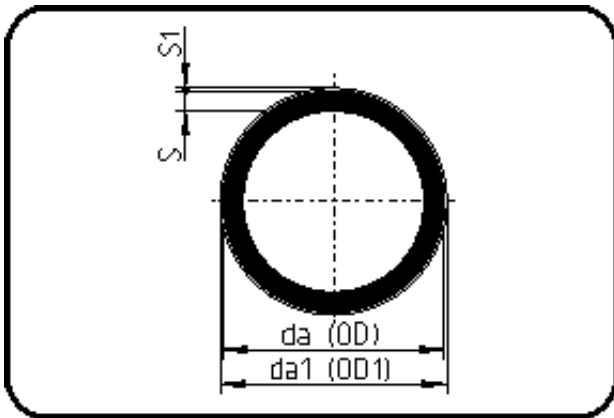

Code: 743

- Pipe SK+ fabric 5m
- Syn. fabric
- extruded
- ECTFE natural

Dim. 200x4.0mm on request.

Dimension	Code	Detail	Weight
25	40.743.0025.00	25x1,9	0.39

	Unit	Nominale	Tol+	Tol-
da(OD)	mm	25	0.30	0.00
s	mm	1,9	0.40	0.00
s1	mm	3,1	0.00	0.00
da(OD1)	mm	27,2	0.00	0.00