

Pipes

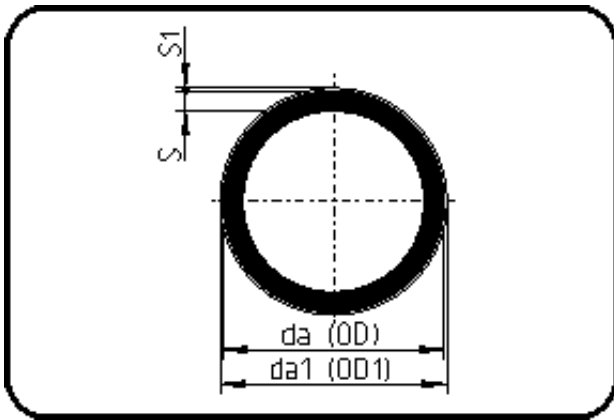

Code: 743.1

- Pipe SK+ fabric 1m
- Syn. fabric
- extruded
- ECTFE natural

Dim. 200x4.0mm on request.

Dimension	Code	Detail	Weight
40	40.743.1040.00	40x2,4	0.73

	Unit	Nominale	Tol+	Tol-
da(OD)	mm	40	0.40	0.00
s	mm	2,4	0.50	0.00
s1	mm	3,6	0.00	0.00
da(OD1)	mm	42,2	0.00	0.00