

Fittings

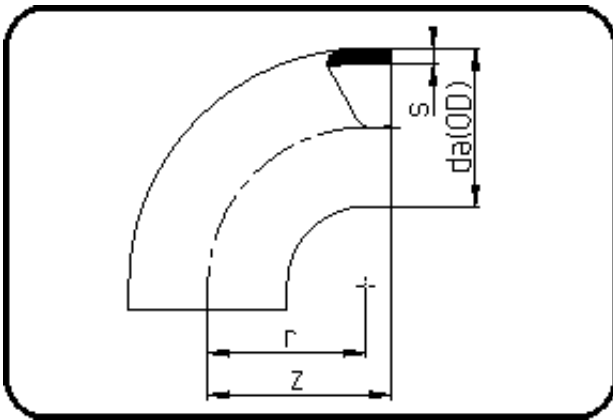

Code: 001

- Bend 90°
- short spigot
- injection moulded
- **Butt + IR-welding**
- PVDF natural HV

Dimension	Code	Detail	Weight
160	3H.001.0160.00	160X3,0	0.95

	Unit	Nominale	Tol+	Tol-
da(OD)	mm	160	1.50	0.00
r	mm	157	0.00	0.00
s	mm	3	0.60	0.00
z	mm	181	2.00	2.00