

Fittings

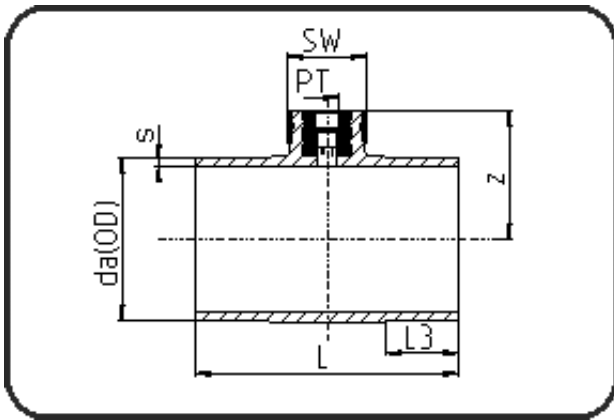

Code: 220

- Sampling Tee
- with PT-female thread
- injection moulded
- **Butt + IR-welding**
- **PVDF UHP natural**

Dimension	Code	Detail	Weight
140	35.220.1432.21	140X1" PT SDR21 ISO S-10	1.20

	Unit	Nominale	Tol+	Tol-
da(OD)	mm	140	0.80	0.00
L	mm	180	2.00	2.00
PT	inch	1	0.00	0.00
SW	mm	70	0.40	0.00
L3	mm	50	1.00	1.00
s	mm	6,7	0.90	0.00
E	mm	33,25	0.00	0.00
K	mm	30,29	0.00	0.00
z	mm	103	2.00	2.00