

## Fittings

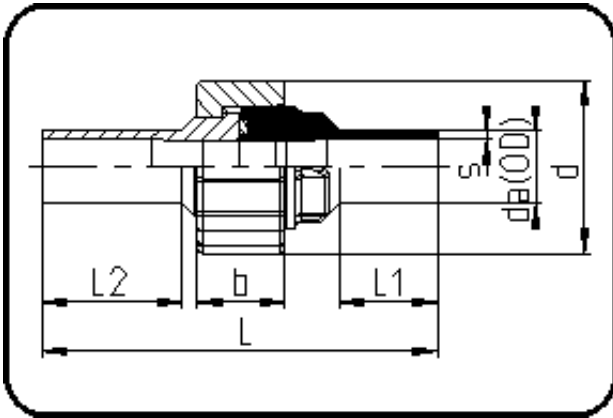

Code: 024

- Union Type 24
- FPM-sealing with FDA Approval
- injection moulded
- **Butt + IR-welding**
- **PP Pure grey**

Dimension	Code	Detail	Weight
32	72.024.0132.11	32X2,9 SDR11 ISO S-5	0.10

	Unit	Nominale	Tol+	Tol-
da(OD)	mm	32	0.30	0.00
L	mm	120	3.00	3.00
L1	mm	25	1.50	1.50
L2	mm	39	1.50	1.50
b	mm	30	0.75	0.75
s	mm	2,9	0.50	0.00
d	mm	64	1.50	1.50