

Fittings

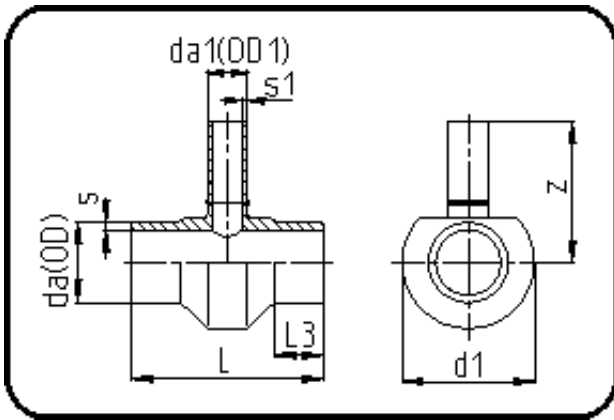

Code: 307

- Tee reduced
- machined
- Butt + IR-welding
- PVDF UHP natural

Dimension	Code	Detail	Weight
90/32	35.307.9032.31	90/32 SDR33/21 MOP 10 bar	0.37

	Unit	Nominale	Tol+	Tol-
da(OD)	mm	90	0.40	0.00
L	mm	149	1.50	1.50
L3	mm	37	1.50	1.50
s	mm	2,8	0.50	0.00
d1	mm	105	0.75	0.75
s1	mm	2,4	0.50	0.00
da(OD1)	mm	32	0.30	0.00
z	mm	153	4.50	4.50