

## Backing Rings, Accessories

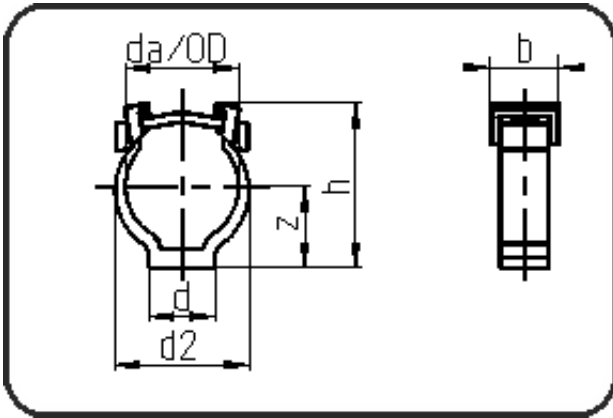

Code: 049.03

- Pipe Clip with cramp
- w.o. steel bracket and screw
- injection moulded
- **Installation Accessory**
- **PP-FRP black**

Dimension	Code	Detail	Weight
110	14.049.0110.03	110	0.24

	Unit	Nominale	Tol+	Tol-
da(OD)	mm	110	0.00	0.00
b	mm	55	0.75	0.75
d	mm	71	0.75	0.75
d2	mm	137	0.75	0.75
h	mm	154,1	2.25	2.25
z	mm	80	0.75	0.75