

Pipes

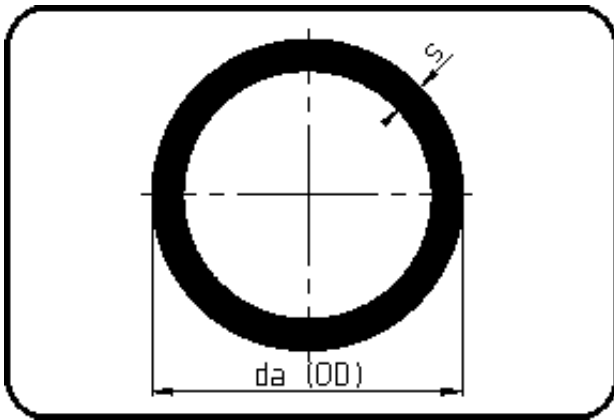

Code: 705

- Pipe 5m
- extruded
- PVDF UHP natural

Dimension	Code	Detail	Weight
40	35.705.0040.21	40X2,4 SDR21 ISO S-10	0.55

	Unit	Nominale	Tol+	Tol-
da(OD)	mm	40	0.40	0.00
s	mm	2,4	0.50	0.00