

Fittings

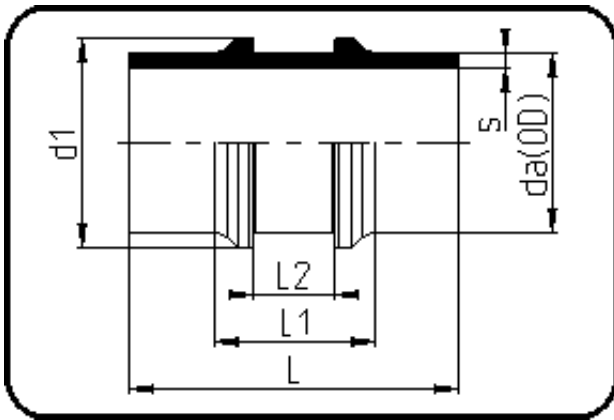

Code: 301

- **Restrained Fitting**
- machined
- **Butt + IR-welding**
- **PP Pure grey**

Dimension	Code	Detail	Weight
40	72.301.0040.11	40X3,7 SDR11 ISO S-5	0.06

	Unit	Nominale	Tol+	Tol-
da(OD)	mm	40	0.40	0.00
L	mm	120	1.50	1.50
L1	mm	53	1.50	1.50
L2	mm	32,5	0.75	0.00
s	mm	3,7	0.50	0.00
d1	mm	48	0.75	0.75