

Fittings

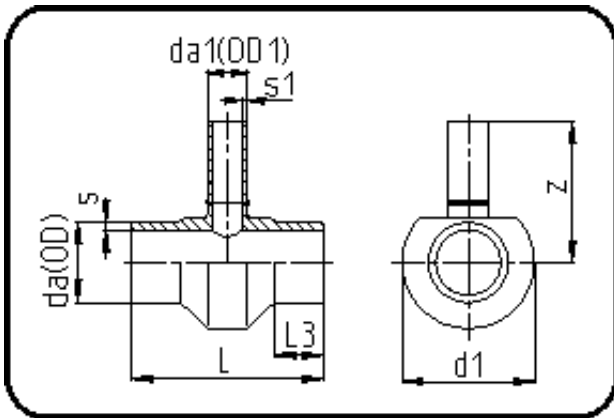

Code: 307

- Tee reduced
- machined
- Butt + IR-welding
- PVDF UHP natural

Dimension	Code	Detail	Weight
140/40	35.307.1440.21	140/40 SDR21 ISO S-10	1.61

	Unit	Nominale	Tol+	Tol-
da(OD)	mm	140	0.80	0.00
L	mm	210	2.00	2.00
L3	mm	50	1.00	1.00
s	mm	6,7	0.90	0.00
d1	mm	150	1.00	1.00
s1	mm	2,4	0.50	0.00
da(OD1)	mm	40	0.40	0.00
z	mm	182	6.00	6.00