

Fittings

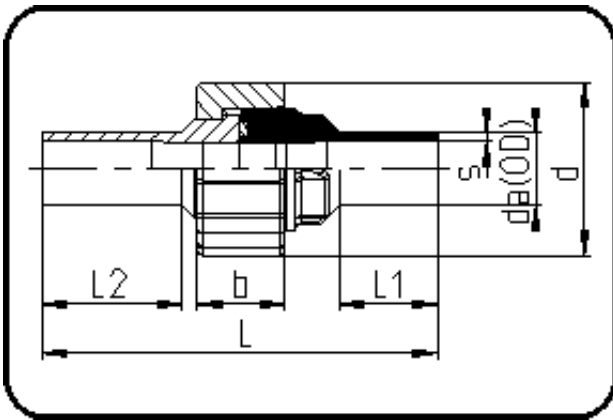

Code: 024

- Union Type 24
- FPM-sealing with FDA Approval
- injection moulded
- **Butt + IR-welding**
- **PP Pure grey**

Dimension	Code	Detail	Weight
20	72.024.0120.11	20X1,9 SDR11 ISO S-5	0.05

	Unit	Nominale	Tol+	Tol-
da(OD)	mm	20	0.30	0.00
L	mm	108	3.00	3.00
L1	mm	24	1.50	1.50
L2	mm	38	1.50	1.50
b	mm	24	0.75	0.75
s	mm	1,9	0.40	0.00
d	mm	47	1.50	1.50