

MULTI Fittings

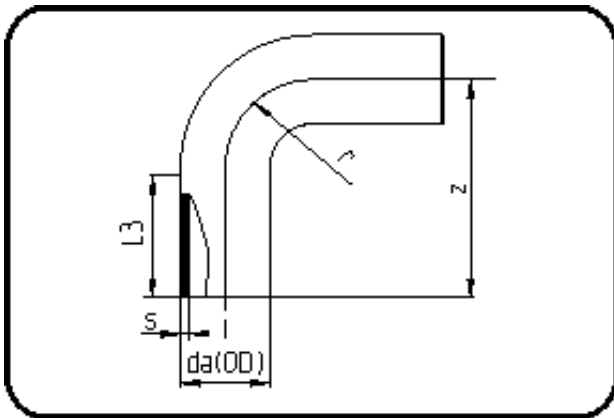

Code: 068

- **MULTI-Bend 90°**
- long spigot
- injection moulded
- **Butt + IR-welding**
- **PP Pure grey**

Dimension	Code	Detail	Weight
200	72.068.0200.11	200X18,2 SDR11 ISO S-5	5.83

	Unit	Nominale	Tol+	Tol-
da(OD)	mm	200	1.80	0.00
L3	mm	118,5	6.00	6.00
r	mm	200	0.00	0.00
s	mm	18,2	2.00	0.00
z	mm	318,5	7.50	7.50