

Fittings

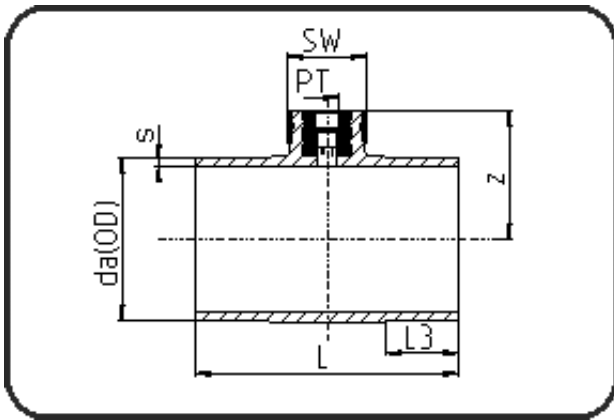

Code: 220

- Sampling Tee
- with PT-female thread
- injection moulded
- **Butt + IR-welding**
- **PP Pure grey**

Dimension	Code	Detail	Weight
75	72.220.7516.11	75X3/8" PT SDR11 ISO S-5	0.37

	Unit	Nominale	Tol+	Tol-
da(OD)	mm	75	0.70	0.00
L	mm	178	3.00	3.00
PT	inch	0,375	0.00	0.00
SW	mm	55	1.00	1.00
L3	mm	42	1.50	1.50
s	mm	6,8	0.80	0.00
E	mm	16,66	0.00	0.00
K	mm	14,95	0.00	0.00
z	mm	70,5	3.00	3.00