

## Fittings

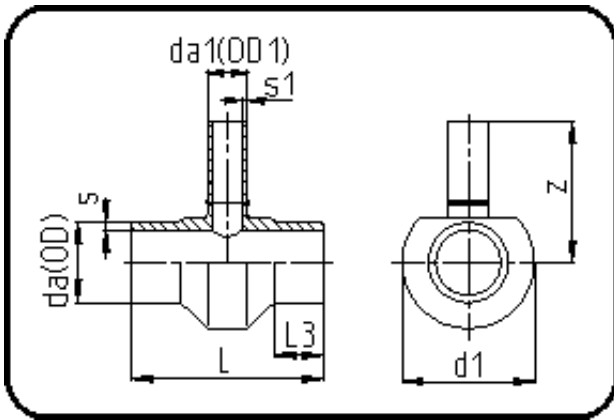

Code: 307

- Tee reduced
- machined
- Butt + IR-welding
- PVDF UHP natural

Dimension	Code	Detail	Weight
110/25	35.307.1125.31	110/25 SDR33/21 MOP 10 bar	0.53

	Unit	Nominale	Tol+	Tol-
da(OD)	mm	110	0.50	0.00
L	mm	150	1.50	1.50
L3	mm	38	1.50	1.50
s	mm	3,4	0.60	0.00
d1	mm	124	0.75	0.75
s1	mm	1,9	0.40	0.00
da(OD1)	mm	25	0.30	0.00
z	mm	163	4.50	4.50