

Fittings

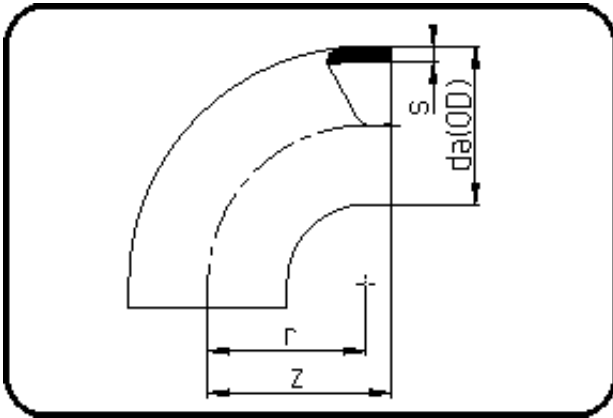

Code: 001

- Bend 90°
- short spigot
- injection moulded
- **Butt + IR-welding**
- **PVDF UHP natural**

Dimension	Code	Detail	Weight
200	35.001.0200.21	200X9,6 SDR21 ISO S-10	3.81

	Unit	Nominale	Tol+	Tol-
da(OD)	mm	200	1.20	0.00
r	mm	196	0.00	0.00
s	mm	9,6	1.20	0.00
z	mm	217	3.00	3.00