

Valves

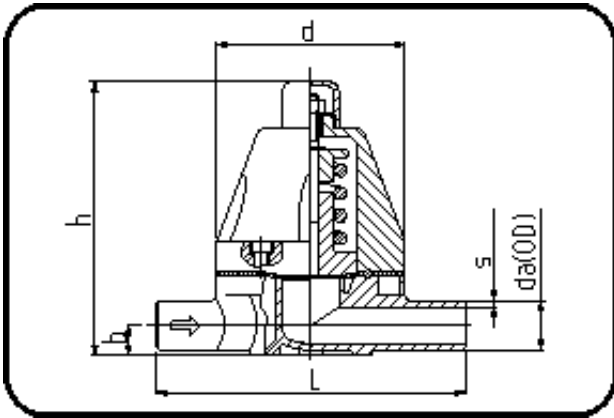

Code: 244

- Pressure retaining valve V186
- PTFE diaphragm
- injection moulded
- **Butt + IR-welding**
- **PVDF UHP natural**

** On request.

Dimension	Code	Detail	Weight
20	35.244.0020.21	20 - SDR21 MOP 10 bar	0.54

	Unit	Nominale	Tol+	Tol-
da(OD)	mm	20	0.30	0.00
L	mm	158	0.00	0.00
b	mm	20	0.00	0.00
DN	mm	15	0.00	0.00
s	mm	1,9	0.40	0.00
d	mm	83	0.00	0.00
p	bar	10	0.00	0.00
h	mm	137	0.00	0.00
da	inch	0,5	0.00	0.00