

## Fittings

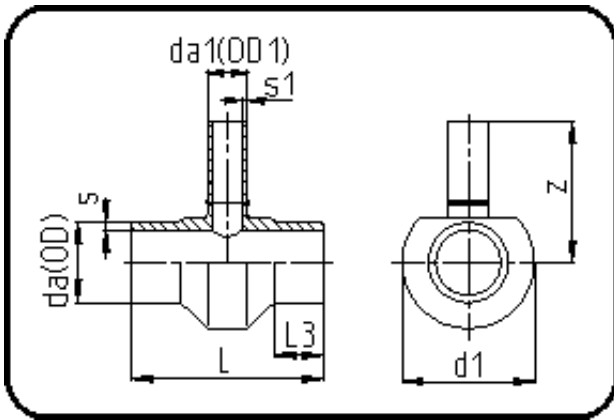

Code: 307

- Tee reduced
- machined
- Butt + IR-welding
- PVDF UHP natural

Dimension	Code	Detail	Weight
75/20	35.307.7520.21	75/20 SDR21 ISO S-10	0.63

	Unit	Nominale	Tol+	Tol-
da(OD)	mm	75	0.40	0.00
L	mm	140	1.50	1.50
L3	mm	33	1.50	1.50
s	mm	3,6	0.60	0.00
d1	mm	105	0.75	0.75
s1	mm	1,9	0.40	0.00
da(OD1)	mm	20	0.30	0.00
z	mm	145,5	4.50	4.50