

Backing Rings, Accessories

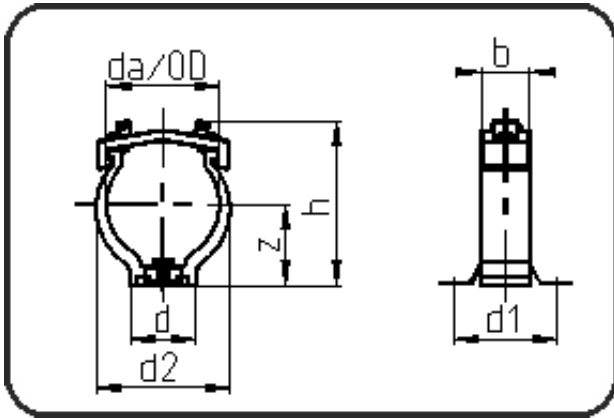

Code: 049

- Pipe Clip
- injection moulded
- Installation Accessory
- PP-FRP black

Dimension	Code	Detail	Weight
200	14.049.0200.00	200	1.17

	Unit	Nominale	Tol+	Tol-
da(OD)	mm	200	0.00	0.00
b	mm	60	0.00	0.75
d	mm	145	0.75	0.75
d1	mm	110	0.75	0.75
d2	mm	238	0.75	0.75
h	mm	266,5	2.25	2.25
z	mm	148	0.75	0.75