

Backing Rings, Accessories

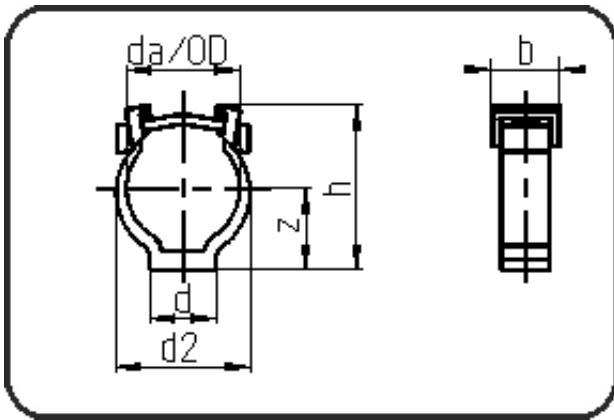

Code: 049.03

- Pipe Clip with cramp
- w.o. steel bracket and screw
- injection moulded
- **Installation Accessory**
- **PP-FRP black**

Dimension	Code	Detail	Weight
125	14.049.0125.03	125	0.46

	Unit	Nominale	Tol+	Tol-
da(OD)	mm	125	0.00	0.00
b	mm	75	0.00	0.75
d	mm	91	0.75	0.75
d2	mm	155	0.75	0.75
h	mm	178,5	2.25	2.25
z	mm	93	0.75	0.75