

Fittings

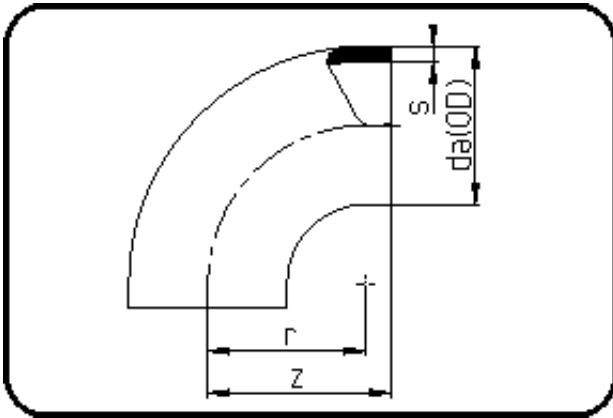

Code: 001

- Bend 90°
- short spigot
- injection moulded
- **Butt + IR-welding**
- **PVDF UHP natural**

Dimension	Code	Detail	Weight
180	35.001.0180.21	180X8,6 SDR21 ISO S-10	2.88

	Unit	Nominale	Tol+	Tol-
da(OD)	mm	180	1.10	0.00
r	mm	175	0.00	0.00
s	mm	8,6	1.10	0.00
z	mm	200	3.00	3.00