

Fittings

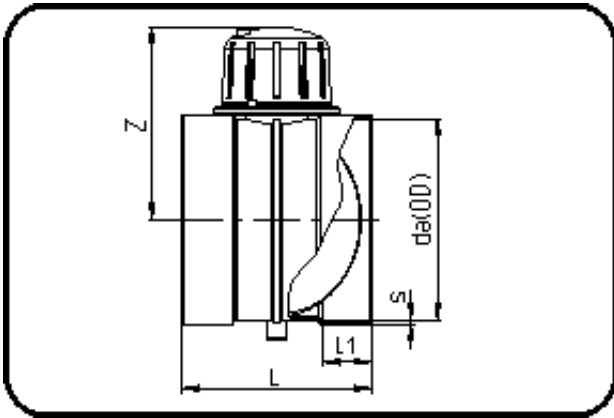

Code: 34.008

- Throttle Valve
- for pressureless applications
- injection moulded
- **Hot-gas-welding**
- **AGRU-Vent PVDF**

Dimension	Code	Detail	Weight
63	34.008.0063.00	63X3,0	0.36

	Unit	Nominale	Tol+	Tol-
da(OD)	mm	63	0.00	0.00
L	mm	130	0.00	0.00
L1	mm	35	0.00	0.00
s	mm	3	0.60	0.00
z	mm	95	0.00	0.00