

## Fittings

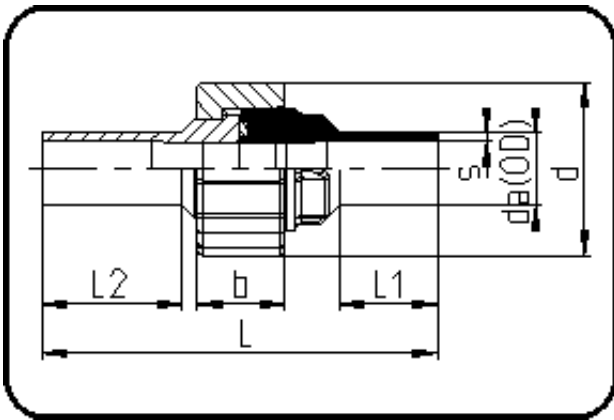

Code: 024

- Union Type 24
- FPM-sealing with FDA Approval
- injection moulded
- **Butt + IR-welding**
- **PP Pure grey**

Dimension	Code	Detail	Weight
63	72.024.0163.11	63X5,8 SDR11 ISO S-5	0.38

	Unit	Nominale	Tol+	Tol-
da(OD)	mm	63	0.60	0.00
L	mm	138	3.00	3.00
L1	mm	25	1.50	1.50
L2	mm	44	1.50	1.50
b	mm	39	0.75	0.75
s	mm	5,8	0.80	0.00
d	mm	109	1.50	1.50