

Fittings

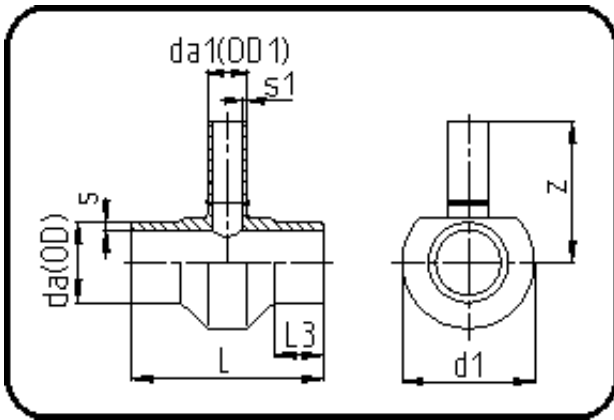

Code: 307

- Tee reduced
- machined
- Butt + IR-welding
- PVDF UHP natural

Dimension	Code	Detail	Weight
160/40	35.307.1640.21	160/40 SDR21 ISO S-10	2.02

	Unit	Nominale	Tol+	Tol-
da(OD)	mm	160	1.00	0.00
L	mm	210	2.00	2.00
L3	mm	50	1.00	1.00
s	mm	7,7	1.00	0.00
d1	mm	170	1.00	1.00
s1	mm	2,4	0.50	0.00
da(OD1)	mm	40	0.40	0.00
z	mm	192	6.00	6.00