

## Fittings

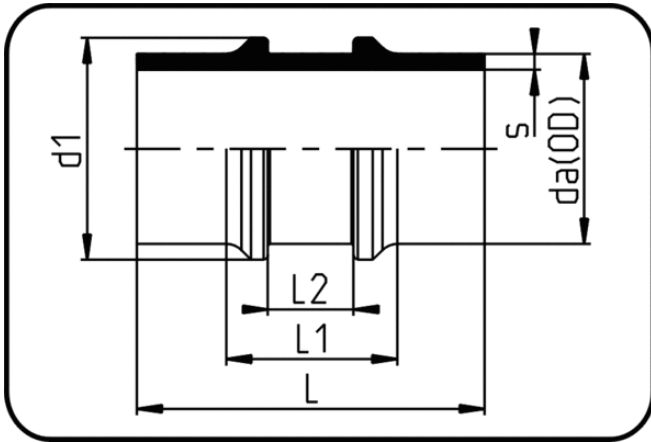

Code: 301

- **Restrained Fitting**
- machined
- **Butt + IR-welding**
- **PVDF UHP natural**

Dimension	Code	Detail	da(OD) mm	s mm	L mm	L2 mm	d1 mm	L1 mm	Weight
25	35.301.0025.21	25x1,9 SDR 21/ISO-S10	25	1,9	120	33	33	68	0.05
40	35.301.0040.21	40x2,4 SDR 21/ISO-S10	40	2,4	120	33	48	68	0.07
50	35.301.0050.21	50x3,0 SDR 21/ISO-S10	50	3	120	33	58	68	0.13
75	35.301.0075.21	75x3,6 SDR 21/ISO-S10	75	3,6	150	40,5	87	75	0.34