

Fittings

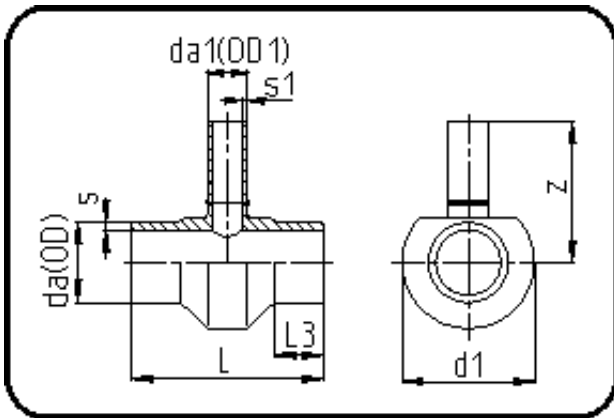

Code: 307

- Tee reduced
- machined
- Butt + IR-welding
- PVDF UHP natural

Dimension	Code	Detail	Weight
160/20	35.307.1620.31	160/20 SDR33/21 MOP 10 bar	1.45

	Unit	Nominale	Tol+	Tol-
da(OD)	mm	160	1.00	0.00
L	mm	158	1.50	1.50
L3	mm	30	1.50	1.50
s	mm	4,9	0.70	0.00
d1	mm	178	0.75	0.75
s1	mm	1,9	0.40	0.00
da(OD1)	mm	20	0.30	0.00
z	mm	188	4.50	4.50