

Fittings

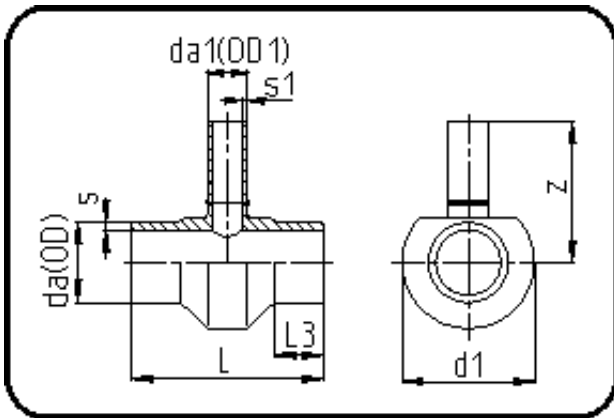

Code: 307

- Tee reduced
- machined
- Butt + IR-welding
- PVDF UHP natural

Dimension	Code	Detail	Weight
75/32	35.307.7532.21	75/32 SDR21 ISO S-10	0.38

	Unit	Nominale	Tol+	Tol-
da(OD)	mm	75	0.40	0.00
L	mm	140	3.00	3.00
L3	mm	35	1.50	1.50
s	mm	3,6	0.60	0.00
d1	mm	85	1.50	1.50
s1	mm	2,4	0.50	0.00
da(OD1)	mm	32	0.30	0.00
z	mm	149,5	4.50	4.50