

Pipes

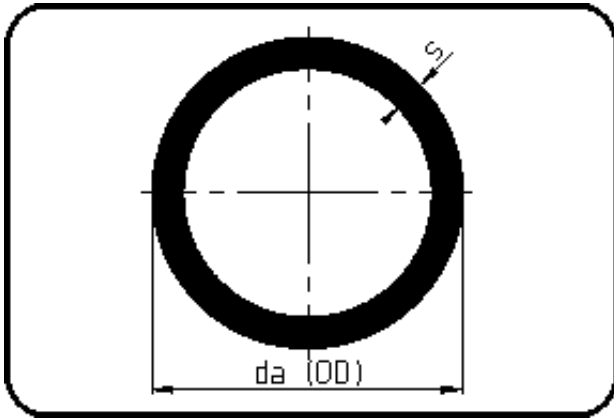

Code: 705

- Pipe 5m
- extruded
- PVDF UHP natural

Dimension	Code	Detail	Weight
20	35.705.0020.21	20X1,9 SDR21 ISO S-10	0.21

	Unit	Nominale	Tol+	Tol-
da(OD)	mm	20	0.30	0.00
s	mm	1,9	0.40	0.00