

## Fittings

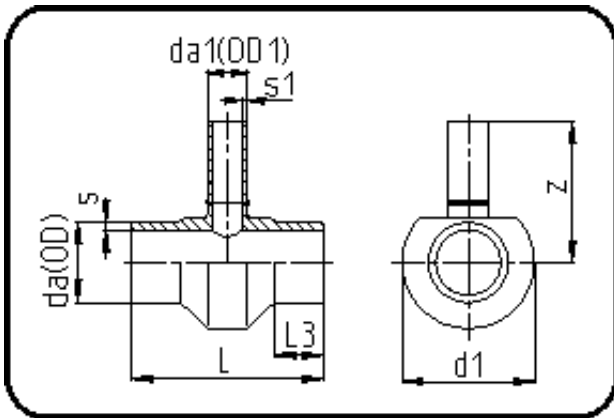

Code: 307

- Tee reduced
- machined
- Butt + IR-welding
- PVDF UHP natural

Dimension	Code	Detail	Weight
225/20	35.307.2220.21	225/20 SDR21 ISO S-10	2.55

	Unit	Nominale	Tol+	Tol-
da(OD)	mm	225	1.40	0.00
L	mm	130	2.00	2.00
L3	mm	30	1.50	1.50
s	mm	10,8	1.30	0.00
d1	mm	250	2.00	2.00
s1	mm	1,9	0.40	0.00
da(OD1)	mm	20	0.30	0.00
z	mm	221,5	4.50	4.50