

Fittings

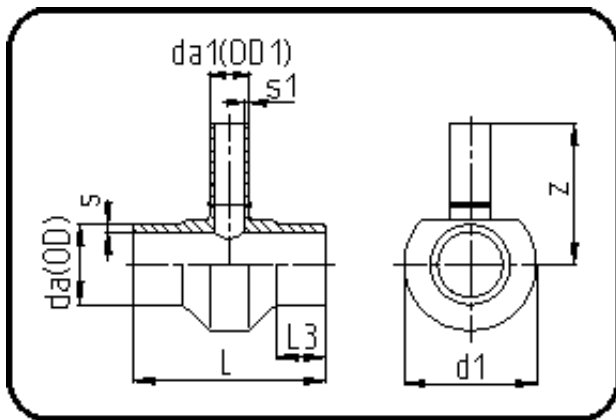

Code: 307

- Tee reduced
- machined
- Butt + IR-welding
- PVDF UHP natural

Dimension	Code	Detail	Weight
140/32	35.307.1432.21	140/32 SDR21 ISO S-10	1.44

	Unit	Nominale	Tol+	Tol-
da(OD)	mm	140	0.80	0.00
L	mm	158	1.50	1.50
L3	mm	30	1.50	1.50
s	mm	6,7	0.90	0.00
d1	mm	157	0.75	0.75
s1	mm	2,4	0.50	0.00
da(OD1)	mm	32	0.30	0.00
z	mm	177,5	4.50	4.50