

Fittings

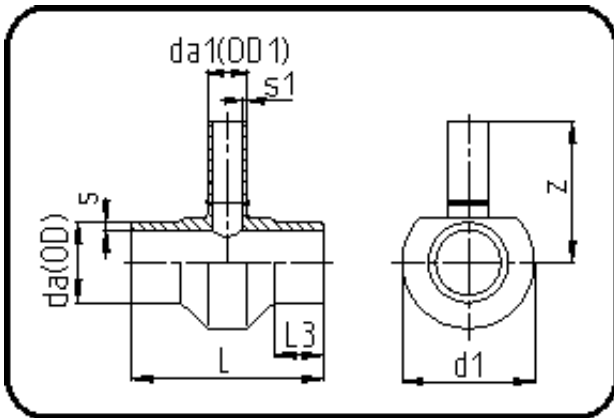

Code: 307

- Tee reduced
- machined
- Butt + IR-welding
- PVDF UHP natural

Dimension	Code	Detail	Weight
225/110	35.307.2211.21	225/110 SDR21 ISO S-10	5.49

	Unit	Nominale	Tol+	Tol-
da(OD)	mm	225	1.40	0.00
L	mm	280	3.00	3.00
L3	mm	55	1.50	1.50
s	mm	10,8	1.30	0.00
d1	mm	278	1.50	1.50
s1	mm	5,3	0.80	0.00
da(OD1)	mm	110	0.50	0.00
z	mm	227,5	9.00	9.00