

Backing Rings, Accessories

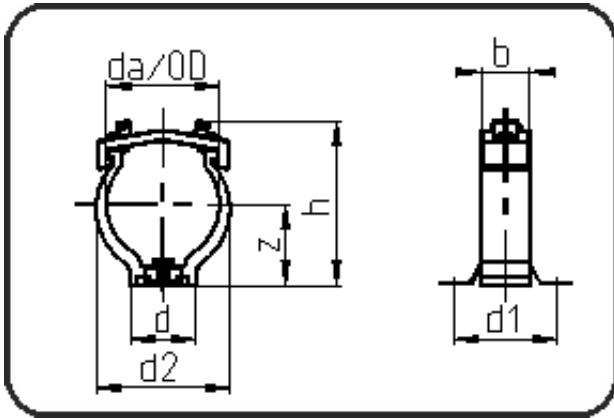

Code: 049

- Pipe Clip
- injection moulded
- Installation Accessory
- PP-FRP black

Dimension	Code	Detail	Weight
90	14.049.0090.00	90	0.16

	Unit	Nominale	Tol+	Tol-
da(OD)	mm	90	0.00	0.00
b	mm	40	0.00	0.75
d	mm	57	0.75	0.75
d1	mm	82	0.75	0.75
d2	mm	108	0.75	0.75
h	mm	134,2	2.25	2.25
z	mm	67	0.75	0.75