

Backing Rings, Accessories

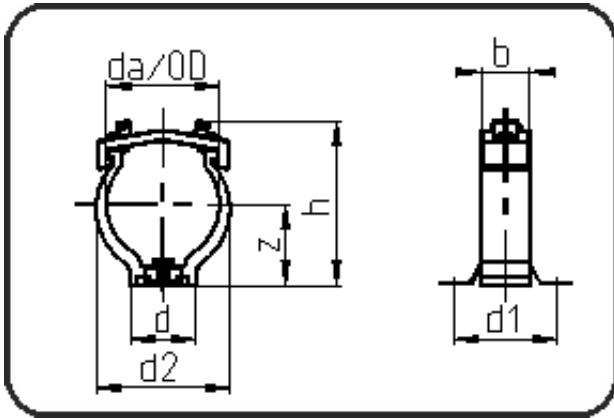

Code: 049

- Pipe Clip
- injection moulded
- Installation Accessory
- PP-FRP black

Dimension	Code	Detail	Weight
75	14.049.0075.00	75	0.19

	Unit	Nominale	Tol+	Tol-
da(OD)	mm	75	0.00	0.00
b	mm	40	0.00	0.75
d	mm	55	0.75	0.75
d1	mm	82	0.75	0.75
d2	mm	94	0.75	0.75
h	mm	121,9	2.25	2.25
z	mm	61	0.75	0.75