

Fittings

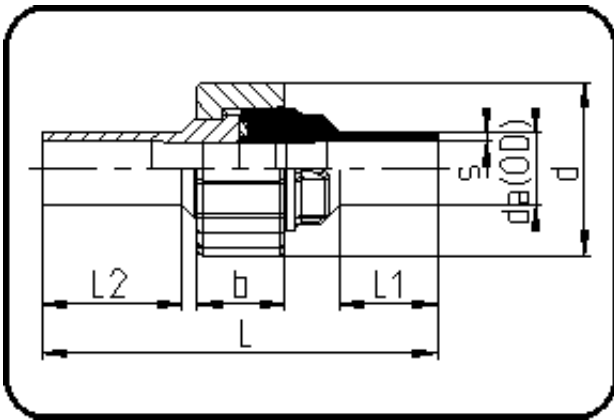

Code: 024

- Union Type 24
- FPM-sealing with FDA Approval
- injection moulded
- **Butt + IR-welding**
- **PP Pure grey**

Dimension	Code	Detail	Weight
40	72.024.0140.11	40X3,7 SDR11 ISO S-5	0.17

	Unit	Nominale	Tol+	Tol-
da(OD)	mm	40	0.40	0.00
L	mm	128	3.00	3.00
L1	mm	25	1.50	1.50
L2	mm	42	1.50	1.50
b	mm	31	0.75	0.75
s	mm	3,7	0.60	0.00
d	mm	78	1.50	1.50