

Drainage Pipes

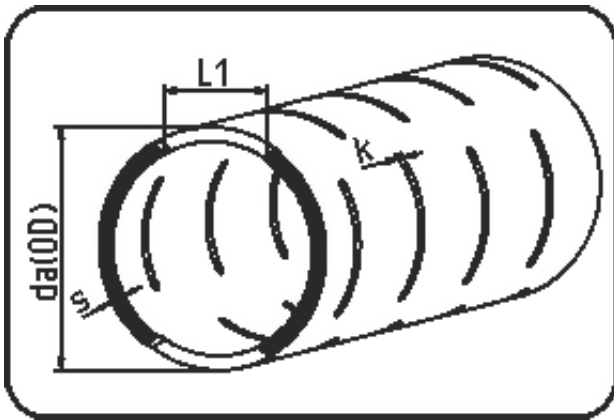

Code: 733

- Drainage Pipe 12m
- fully slotted
- extruded+slotted
- PE 100 black

Not available from stock - delivery time on request.

Dimension	Code	Detail	Weight
63	25.733.0063.11	63X5,8 SDR11 ISO S-5	1.06

	Unit	Nominale	Tol+	Tol-
da(OD)	mm	63	0.40	0.00
L1	mm	43	4.50	4.50
s	mm	5,8	0.70	0.00
K	mm	3/4/6/8/10	8.00	6.50