

Drainage Pipes

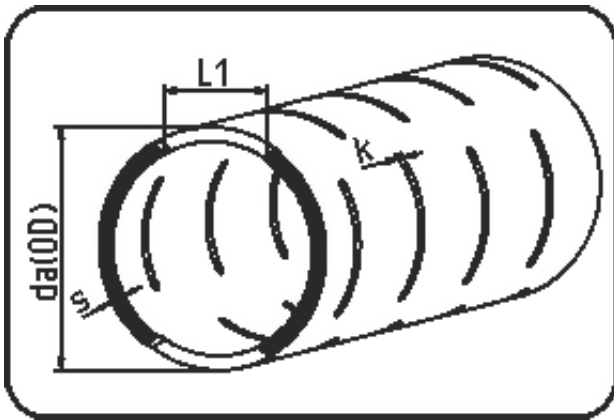

Code: 733

- Drainage Pipe 12m
- fully slotted
- extruded+slotted
- PE 100 black

Not available from stock - delivery time on request.

Dimension	Code	Detail	Weight
250	25.733.0250.17	250X14,8 SDR17 ISO S-8	11.10

	Unit	Nominale	Tol+	Tol-
da(OD)	mm	250	0.40	0.00
L1	mm	83	4.50	4.50
s	mm	14,8	0.70	0.00
K	mm	3/4/6/8/10	10.00	8.50