

Drainage Pipes

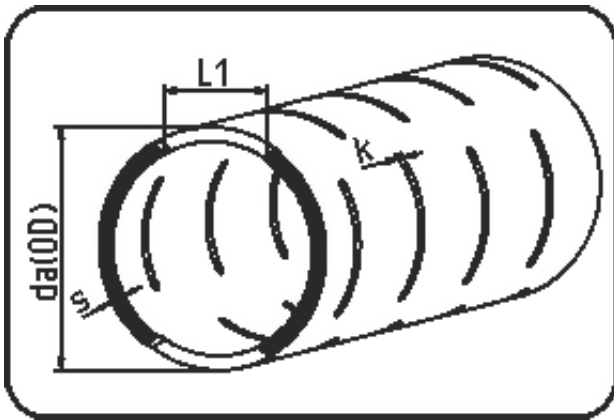

Code: 733

- Drainage Pipe 12m
- fully slotted
- extruded+slotted
- PE 100 black

Not available from stock - delivery time on request.

Dimension	Code	Detail	Weight
180	25.733.0180.17	180X10,7 SDR17 ISO S-8	5.77

	Unit	Nominale	Tol+	Tol-
da(OD)	mm	180	0.50	0.00
L1	mm	84	4.50	4.50
s	mm	10,7	0.80	0.00
K	mm	3/4/6/8/10	8.00	6.50