

Drainage Pipes

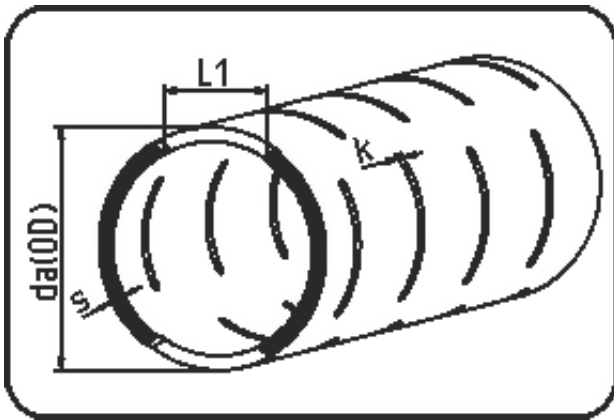

Code: 733

- Drainage Pipe 12m
- fully slotted
- extruded+slotted
- PE 100 black

Not available from stock - delivery time on request.

Dimension	Code	Detail	Weight
90	25.733.0090.11	90X8,2 SDR11 ISO S-5	2.14

	Unit	Nominale	Tol+	Tol-
da(OD)	mm	90	0.40	0.00
L1	mm	48	4.50	4.50
s	mm	8,2	0.70	0.00
K	mm	3/4/6/8/10	8.00	6.50