

Drainage Pipes

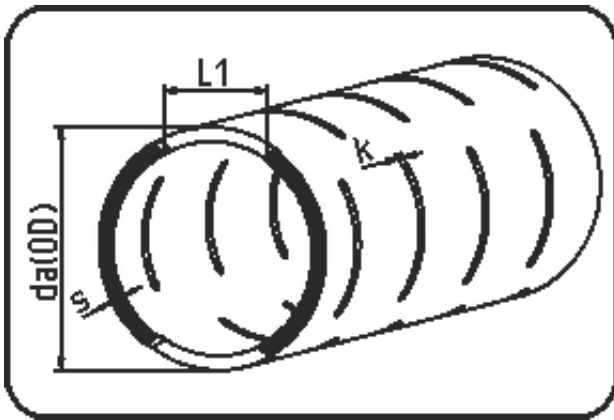

Code: 733

- Drainage Pipe 12m
- fully slotted
- extruded+slotted
- PE 100 black

Not available from stock - delivery time on request.

Dimension	Code	Detail	Weight
315	25.733.0315.11	315X28,6 SDR11 ISO S-5	25.90

	Unit	Nominale	Tol+	Tol-
da(OD)	mm	315	0.40	0.00
L1	mm	65	4.50	4.50
s	mm	28,6	0.70	0.00
K	mm	4/6/8/10	10.00	8.50