

Drainage Pipes

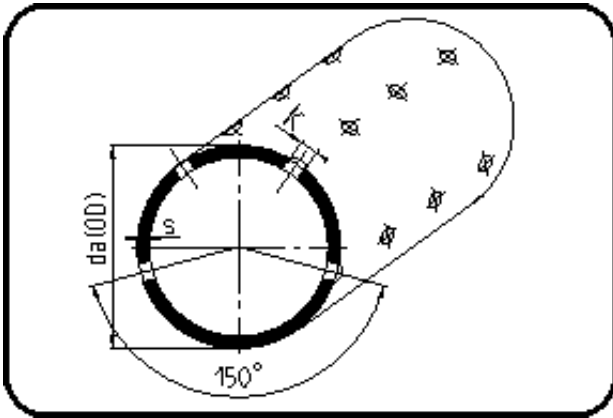

Code: 730

- Drainage Pipe 12m
- 2/3 perforated
- extruded+drilled
- PE 100 black

Not available from stock - delivery time on request.

Dimension	Code	Detail	Weight
200	25.730.0200.17	200X11,9 SDR17 ISO S-8	7.12

	Unit	Nominale	Tol+	Tol-
da(OD)	mm	200	1.20	0.00
L3	mm	69	3.00	3.00
L4	mm	135	50.00	0.00
s	mm	11,9	1.30	0.00
numb	pc	8	0.00	0.00
K	mm	12	12.75	11.25