

Drainage Pipes

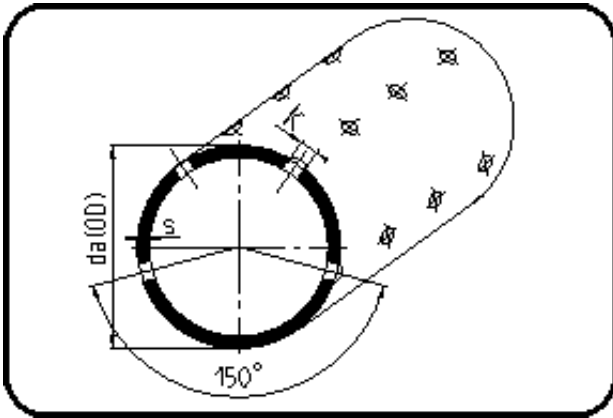

Code: 730

- Drainage Pipe 12m
- 2/3 perforated
- extruded+drilled
- PE 100 black

Not available from stock - delivery time on request.

Dimension	Code	Detail	Weight
75	25.730.0075.11	75X6,8 SDR11 ISO S-5	1.48

	Unit	Nominale	Tol+	Tol-
da(OD)	mm	75	0.50	0.00
L3	mm	67	3.00	3.00
L4	mm	80	30.00	0.00
s	mm	6,8	0.80	0.00
numb	pc	4	0.00	0.00
K	mm	12	12.75	11.25