

Drainage Pipes

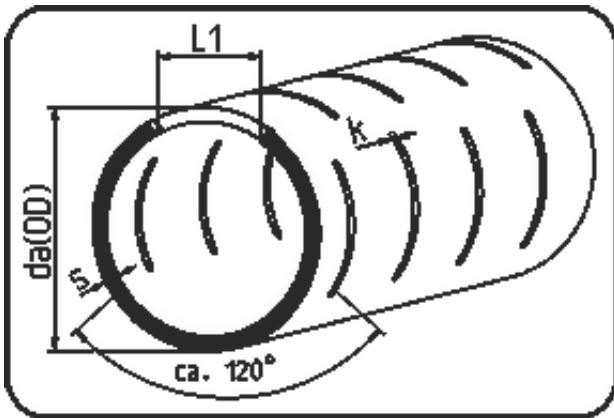

Code: 732

- Drainage Pipe 12m
- 2/3 slotted
- extruded+slotted
- PE 100 black

Not available from stock - delivery time on request.

Dimension	Code	Detail	Weight
75	25.732.0075.11	75X6,8 SDR11 ISO S-5	1.48

	Unit	Nominale	Tol+	Tol-
da(OD)	mm	75	0.50	0.00
L1	mm	46	1.05	0.00
s	mm	6,8	0.80	0.00
K	mm	3/4/6/8/10	5.00	3.50