

Drainage Pipes

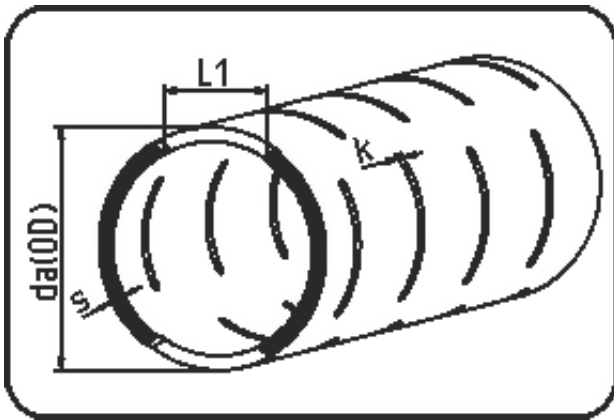

Code: 733

- Drainage Pipe 12m
- fully slotted
- extruded+slotted
- PE 100 black

Not available from stock - delivery time on request.

Dimension	Code	Detail	Weight
315	25.733.0315.17	315X18,7 SDR17 ISO S-8	17.60

	Unit	Nominale	Tol+	Tol-
da(OD)	mm	315	0.40	0.00
L1	mm	91	4.50	4.50
s	mm	18,7	2.00	0.00
K	mm	4/6/8/10	10.00	8.50