

Drainage Pipes

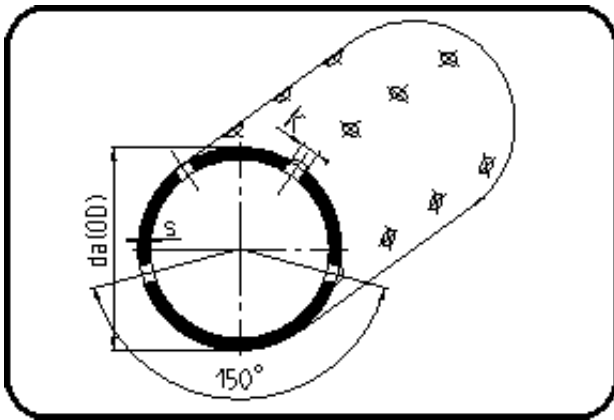

Code: 730

- Drainage Pipe 12m
- 2/3 perforated
- extruded+drilled
- PE 100 black

Not available from stock - delivery time on request.

Dimension	Code	Detail	Weight
280	25.730.0280.11	280X25,4 SDR11 ISO S-5	20.50

	Unit	Nominale	Tol+	Tol-
da(OD)	mm	280	1.70	0.00
L3	mm	52	3.00	3.00
L4	mm	153	50.00	0.00
s	mm	25,4	4.00	0.00
numb	pc	8	0.00	0.00
K	mm	12	12.75	11.25