

Drainage Pipes

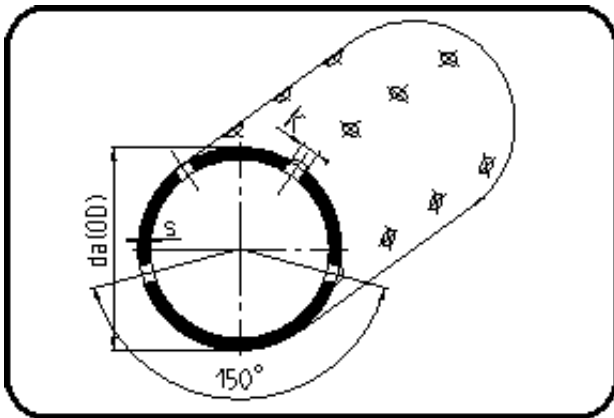

Code: 730

- Drainage Pipe 12m
- 2/3 perforated
- extruded+drilled
- PE 100 black

Not available from stock - delivery time on request.

Dimension	Code	Detail	Weight
125	25.730.0125.17	125X7,4 SDR17 ISO S-8	2.79

	Unit	Nominale	Tol+	Tol-
da(OD)	mm	125	0.80	0.00
L3	mm	62	3.00	3.00
L4	mm	121	30.00	0.00
s	mm	7,4	0.90	0.00
numb	pc	8	0.00	0.00
K	mm	10	10.75	9.25