

## Drainage Pipes

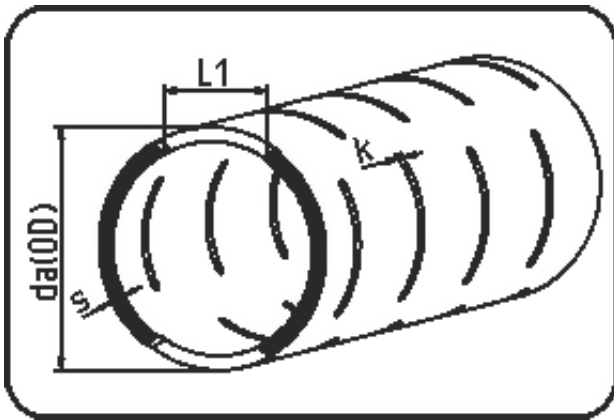

Code: 733

- Drainage Pipe 12m
- fully slotted
- extruded+slotted
- PE 100 black

Not available from stock - delivery time on request.

Dimension	Code	Detail	Weight
160	25.733.0160.11	160X14,6 SDR11 ISO S-5	6.74

	Unit	Nominale	Tol+	Tol-
da(OD)	mm	160	1.00	0.00
L1	mm	72	4.50	4.50
s	mm	14,6	1.60	0.00
K	mm	3/4/6/8/10	8.00	6.50