

Drainage Pipes

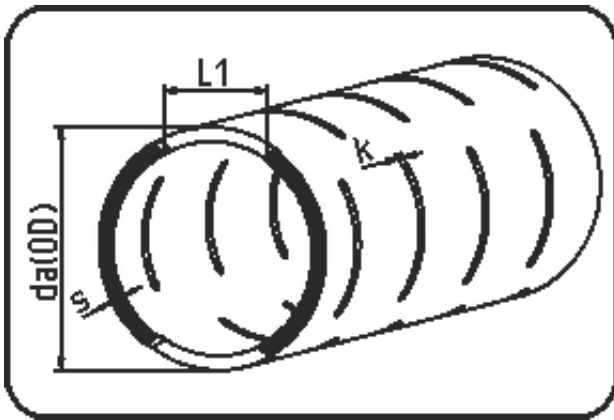

Code: 733

- Drainage Pipe 12m
- fully slotted
- extruded+slotted
- PE 100 black

Not available from stock - delivery time on request.

Dimension	Code	Detail	Weight
110	25.733.0110.17	110X6,6 SDR17 ISO S-8	2.19

	Unit	Nominale	Tol+	Tol-
da(OD)	mm	110	0.50	0.00
L1	mm	56	4.50	4.50
s	mm	6,6	0.80	0.00
K	mm	3/4/6/8/10	8.00	6.50